

Dynamic properties of an unfilled and filled epoxy resin subjected to extensional creep

D. KATZ, Y. SMOOHA, A. I. ISAYEV

Department of Materials Engineering, Technion-Israel Institute of Technology, Haifa, Israel

Dynamic properties of samples of an epoxy resin unfilled and filled with glass beads subjected to extensional creep were studied. The investigated epoxy resin was EPON 826 cured with diethylenetriamine (DETA). The real modulus of both the unfilled and filled resins decreased during creep of the samples. The extent of the decrease was higher in the filled resin, presumably due to wetting-dewetting processes occurring in the filler-matrix interphase. In most cases, the loss modulus also decreased during the creep process of the investigated materials. In cases when the load was removed, most of the initial dynamic properties of the samples recovered after the materials relaxed from the applied load. A correlation between the dynamic properties of the investigated material and the axial strain during creep was found.

1. Introduction

Dynamic measurements are widely used in the investigation of the structure-properties relationship of polymers in the linear range of their behaviour [1-3]. These measurements should not affect the properties and the structure of the polymers during the experiment. On the other hand, when large static or cyclic deformations take place, a change in the structure and properties of the polymer may occur and this change can be determined and measured in small-amplitude dynamic tests superimposed on experiments in which the polymer is subjected to large static or cyclic deformations. This idea has been widely used in the investigation of fluid and rubbery states of polymers [4-11], but only a few papers described work done on polymers below and close to their T_g [12-14]. Crissman and Zapas [12] investigated the dynamic mechanical behaviour of polyethylene and an ethylene-hexene copolymer during creep to failure in uniaxial tension. They found that the tangent of the loss angle slightly increased when the load was applied, decreased afterwards, passed through a minimum at deformations of approximately 10% and sharply grew with further increase in deformation, up to failure. It was suggested that the increase in

damping in the case of the above-mentioned polymers subjected to larger deformations, is due to the increasing concentration of defects within the crystallites.

Falk *et al.* [13] carried out similar experiments on thin samples of several other materials (polyethylene, rubber hydrochloride, cellulose film and kraft paper). They found that the storage modulus and the logarithmic decrement did not change when small loads were imposed on the samples. Large loads, when applied or removed, caused an immediate rise of the damping followed by a gradual decrease of its magnitude until it reached a value characteristic for the undeformed state. No change in the storage modulus was observed in these experiments after a long enough time had passed since the load application or removal.

Lifshitz and Rotem [14] investigated the behaviour of unfilled and filled epoxy and polyester resins subjected to extension at two deformation rates. It was shown in their experiments that the dynamic shear and extensional modulus decreased with the increase of axial deformation. The damping remained constant at low deformations, it increased in filled resins at larger strains until failure occurred, whereas for the unfilled resins the curves exhibited maxima just

before failure. The increase in damping was more significant than the decrease in the modulus. The authors [14] assumed that changes in the dynamic properties of the filled polymers are caused by a dewetting process, while for the unfilled resins changes are a consequence of formation of microscopic vacuoles in the matrix; both assumptions were not experimentally checked further.

The aim of the present work is to determine experimentally the effect of axial deformation during extensional creep under different stresses, on the dynamic properties of a cross-linked epoxy resin. An attempt will be made to find a correlation between the axial strain and the dynamic properties of the investigated material and to relate the mechanical properties of the polymer to structural changes occurring in the strained material.

Data from literature will be used to confirm the applicability of the above approach to other polymeric materials.

2. Experimental details

2.1. Materials and sample preparation

The epoxy resin used for this study was "EPON Resin 826", a product of Shell Chemical Co., cured with diethylenetriamine manufactured by E. Merck. The component ratio of resin to curing agent was 6.2 g to 1.0 g, respectively, as used by Katz and Buchman [15]. The resin and hardener were mixed, degassed in a vacuum chamber for 20 min and cast into the sample casting mould. The mould with the mixture was heated for 15 min at 35°C, for an additional 2 h at 105°C and afterwards cooled slowly in the oven to room temperature.

The mould consisted of two glass plates separated by a 2 mm thick Teflon frame (length 6 cm, width 2.5 cm). To avoid the cross-linked epoxy resin sticking to the glass surfaces, the glass plates were previously dipped in a 1:1 mixture of dimethyldichlorosilane:carbon tetrachloride, dried afterwards for 15 min in air and heated for 4 h at 150°C.

After completion of the curing process, the epoxy plate was cut to test specimens (dimensions: 2.0 mm × 1.8 mm × 27.0 mm). The specimens were installed 7 mm inside each grip of the testing apparatus, glued to these grips by the same resin-hardener mixture used for the preparation of the specimens. The same curing procedure as the one used for the sample preparation was repeated. Additional samples were prepared, but these also

contained a certain amount of filler. Glass beads, a product of Ballotini Co, grade "ac" (149 to 250 μm) were used for this purpose. The beads were heated in an oven at a temperature of 450°C for 6 h, cleaned by refluxed isopropyl alcohol for 24 h and then dried in an oven at 105°C for 2 h. The volume fraction of glass beads in the filled specimens was 43%. In order to avoid settling of the filler during the curing process of the filled resin specimens, the mould was rotated in the oven at a rate of 5 rpm.

2.2. Apparatus

The samples were investigated by use of an apparatus designed and built for this purpose, Fig. 1. The device is a combination of a torsion pendulum and a tension creep tester. The load-carrying bar is free to move vertically but is restricted from rotation by means of precision bearings inserted in a cross-bar. The elongation of the specimen was recorded by a displacement transducer. Thermostating of the specimen within a range of ± 1°C was achieved using a small oven regulated with an Eurotherm temperature controller. A hole through the oven made it possible to observe, with the aid of a microscope, changes which occurred in the specimen during the test. The load capacity of the apparatus was 10 kg. It was proved that this load did not affect the modulus and the damping of the torsion wire of the apparatus; its elongation, due to the imposed load, was negligible. The torsion constant of the wire (length 160 mm, diameter 2 mm) was 3.81×10^6 dyn cm (radian of twist)⁻¹.

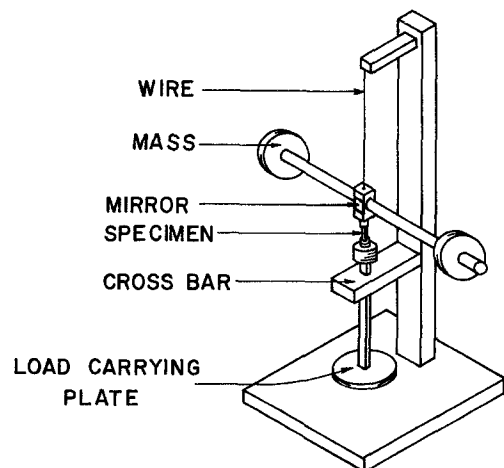

Figure 1 Schematic diagram of the apparatus.

The free damped vibrations of the specimens were measured by means of a laser beam reflected from a mirror attached to the central part of the inertia mass, to a screen located at a distance of 2.5 m from the instrument in order to increase the accuracy of the measurement.

The dynamic properties of the sample were tested before loading, immediately after the load was imposed, at different times during the creep of the specimen, immediately after removal of the load and during the relaxation period. The amplitude of the maximum specimen deformation caused by torsional oscillations with a frequency of about 0.5 Hz did not exceed 0.001 and this deformation did not affect the creep behaviour of the sample. The changes in the specimen's dimensions due to straining were considered in calculation of the dynamic moduli of the polymer. The experiments were carried out at a temperature of $70 \pm 1^\circ \text{C}$, which is below the glass transition of the matrix ($T_g = 117^\circ \text{C}$, according to [15]).

The influence of the axial load on the measured dynamic properties of the tested material depends on the ratio h/b ($b = \text{width}$, $h = \text{thickness}$) of the specimen [16]. The h/b ratio used in this study was near 1, therefore it was unnecessary to account for the axial stress in the calculations. The real modulus G' and the loss modulus G'' were calculated by use of Equations 1 and 2, which are valid in cases in which no axial stresses are acting (see for example [17]), but were corrected for the damping of the torsion wire:

$$G' = \frac{16IL}{\mu b h^3} \left[\omega^2 \left(1 - \frac{\Delta^2}{4\pi^2} \right) - \omega_0^2 \left(1 - \frac{\Delta_0^2}{4\pi^2} \right) \right] \quad (1)$$

$$G'' = \frac{16IL}{\pi \mu b h^3} [\omega^2 \Delta - \omega_0^2 \Delta_0] \quad (2)$$

where I is the moment of inertia, L the length of the specimen; μ the correction factor for the geometry of specimen, ω the angular frequency of oscillations, ω_0 the angular frequency of wire without specimen, Δ the logarithmic decrement of oscillations, and Δ_0 the logarithmic decrement of wire oscillations without specimen. A table which shows the relationship between the shape factor μ and h/b can be found in [19].

3. Results and discussion

3.1. Unfilled specimens

Fig. 2 shows the axial deformation and the relative

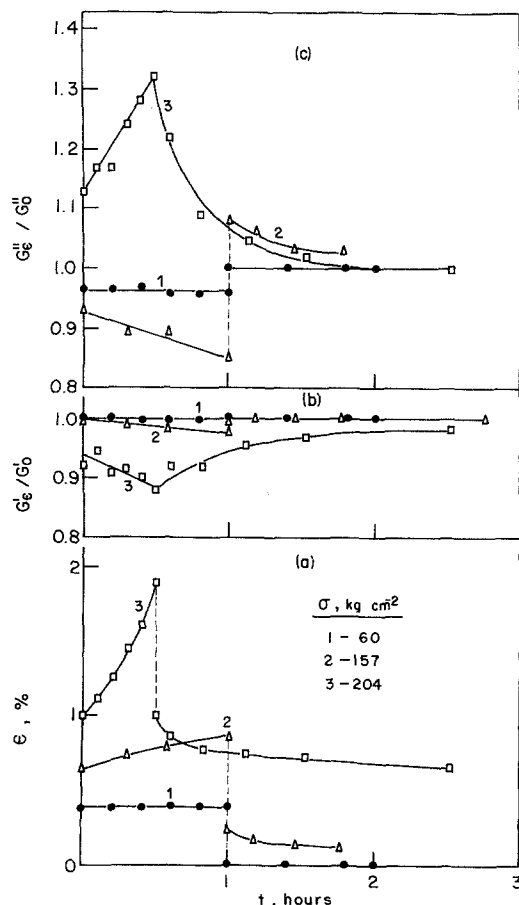

Figure 2 Relationship in unfilled EPON Resin of: (a) axial deformation (b) relative real modulus (c) relative loss modulus versus time of creep and stress and sample relaxation.

values of the dynamic shear moduli versus time for samples of an unfilled epoxy resin at different extensional stresses (left branches of curves) and during relaxation after load removal (right branches of curves). The relative moduli are the ratio between the measured moduli values during deformation (G'_e , G''_e) and the moduli in the undeformed state (G'_0 , G''_0). The values of G'_0 and G''_0 were 3.20×10^9 and $1.05 \times 10^8 \text{ dyn cm}^{-2}$, respectively. Under the low stress of 60 kg cm^{-2} the deformation was elastic, whereas under higher stresses, instantaneous and retarded elastic, as well as plastic deformations were observed. Under the stress of 204 kg cm^{-2} the deformation rate was very high and increased with time; such behaviour indicates a tendency of the sample to rupture. Under the stress of 157 kg cm^{-2} the sample did not show such a tendency, as indicated by the decrease of the strain rate with time.

The dynamic moduli of the material change

during creep and relaxation of the specimen, as shown in Fig. 2b and c. The real modulus diminishes slightly (from 1 to 0.997) under a load of 60 kg cm^{-2} . Under higher stresses the change in the real modulus is more pronounced: it decreases when the load is applied and it continues to fall as the specimen creeps.

The behaviour of the loss modulus under stresses of 60 and 157 kg cm^{-2} is similar to that of the real modulus. An interesting turning point in the behaviour of the loss modulus occurs in samples subjected to the highest stress: It increases when the load is applied and continues to rise with the increase of deformation. Such a behaviour may be related either to a tendency of the sample to fail or may be merely an effect of the high strain rate ($\sim 2.5 \times 10^{-2} \text{ min}^{-1}$ versus $4 \times 10^{-3} \text{ min}^{-1}$ under a stress of 157 kg cm^{-2}). Crissman and Zapas [12] also reported that the mechanical losses increased when the strain rate of the creep test was higher than a certain value ($\sim 0.15 \text{ min}^{-1}$ for polyethylene and 0.012 min^{-1} for the ethylene-hexene co-polymer). As already mentioned, they related the increase in the mechanical losses to accumulation of defects in the polymer crystallites. Lifshitz and Rotem [14], while dealing with a thermosetting system, also observed an almost steady increase in the mechanical losses when tension experiments were performed at two constant strain rates (4.47×10^{-4} and $44.7 \times 10^{-4} \text{ min}^{-1}$). Therefore, it may be assumed that the rise in the mechanical losses is typical for both crystalline and amorphous materials when strained above a certain strain rate and is probably caused by accumulation of defects in the material.

Several interesting effects were observed during the relaxation processes. When the load was removed, the real modulus of the material which had been subjected to low stresses (60 and 157 kg cm^{-2}) regained at once its initial value, as measured before straining. This occurred even when the specimen was still considerably deformed, as seen in case no. 2 in Fig. 2a. In samples which have been subjected to the high stress (204 kg cm^{-2}), a gradual recovery of the real modulus took place after the load removal, but it did not reach its initial value even 1.5 h after the load removal. Consideration of the behaviour of the loss modulus showed an immediate recovery to its initial value, after the sample relaxed from the smallest stress. On the other hand, when the samples relaxed from the moderate stress, the loss

modulus showed higher values than those measured before straining. These values gradually decreased, but did not reach their initial level even when last measured (0.8 h after the stress removal). A similar rise in the mechanical losses after the load removal was also noticed by Falk *et al.* [13] during their investigation of the properties of kraft paper. Yet, in our work, when the specimen relaxed after application of the highest stress, the mechanical losses did not increase as in the previous cases, but gradually decreased to their initial value. It seems that in this case also, in spite of a considerable plastic deformation, the major part of the dynamic properties of the material was regained during relaxation.

3.2. Filled specimens

Data for deformation recorded as a function of time and for the calculated relative moduli in experiments with glass-filled epoxy samples are shown in Fig. 3. The values of G'_0 and G''_0 are 1.21×10^{10} and $2.85 \times 10^8 \text{ dyn cm}^{-2}$, respectively. It is obvious from Fig. 3a that no plastic defor-

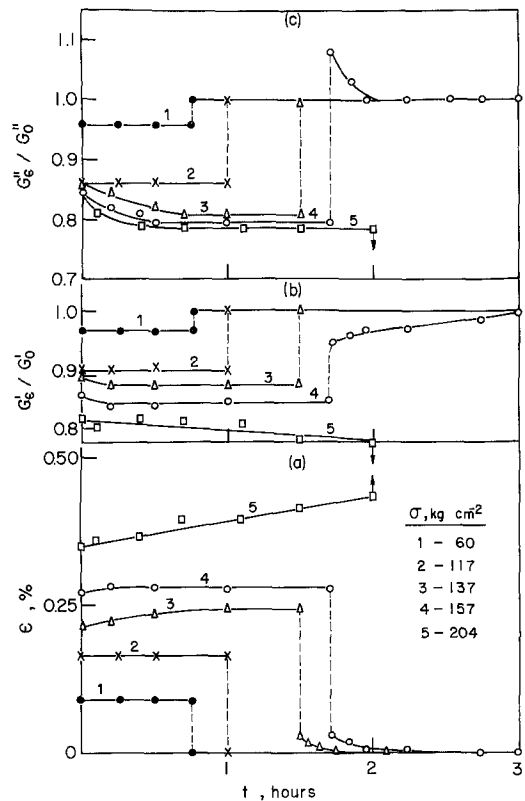

Figure 3 Dependencies of: (a) axial deformation (b) relative real modulus (c) relative loss modulus on time of creep and stress and sample relaxation after stress removal for EPON Resin filled with 43% (volume) of glass beads.

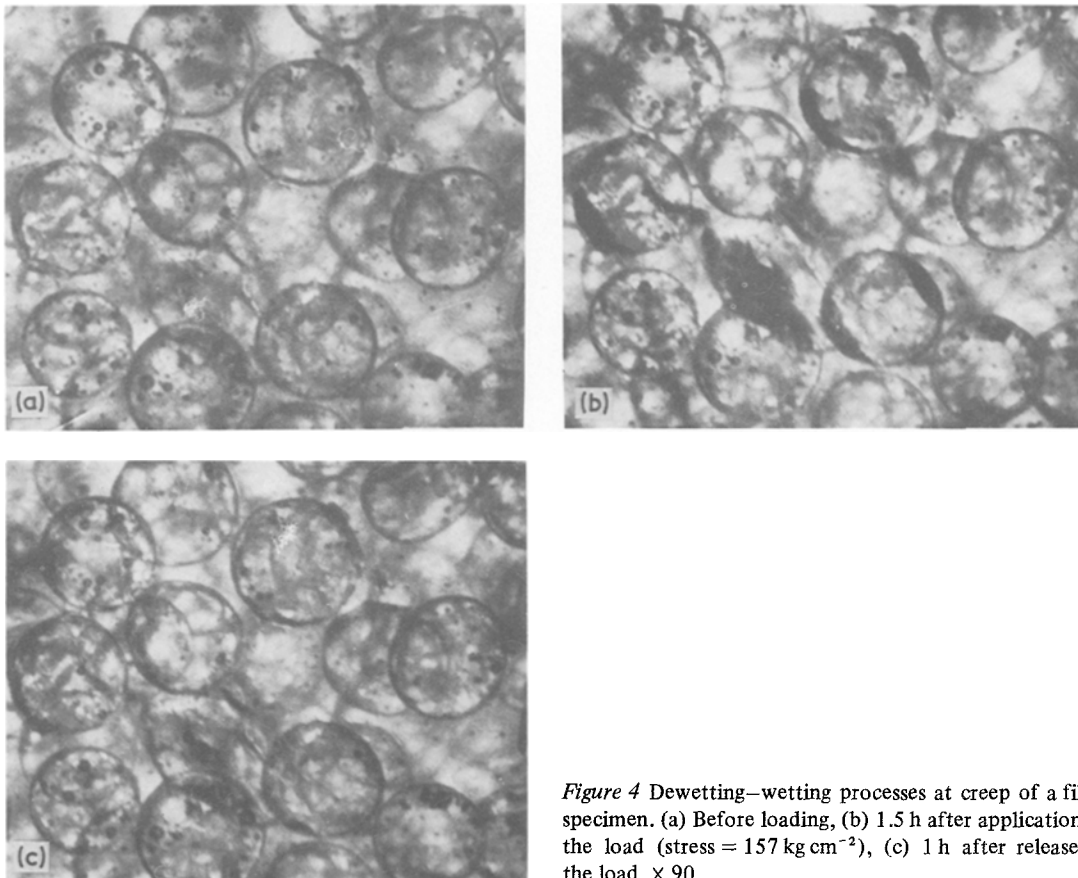

Figure 4 Dewetting–wetting processes at creep of a filled specimen. (a) Before loading, (b) 1.5 h after application of the load (stress = 157 kg cm^{-2}), (c) 1 h after release of the load. $\times 90$

mation occurred in the material up to a tensile stress of 157 kg cm^{-2} . Under a higher stress (204 kg cm^{-2}) the sample ruptured after 2 h of loading. Under stresses of 60 and 117 kg cm^{-2} the samples reached immediately after loading a constant deformation, while under higher stresses of 137 and 157 kg cm^{-2} , a certain amount of creep occurred before the deformation reached a constant value. In case 5 (204 kg cm^{-2}) the creep rate did not level off until failure occurred. After removal of the load, the elastic recovery was immediate in cases 1 and 2, while in cases 3 and 4 the elastic recovery was slightly delayed. In these cases when the load was applied, a structural change in the filled specimens was observed by use of an optical microscope (Fig. 4). The change, separation between the matrix and the filler in the process of “dewetting”, was caused by separation of the epoxy resin from the glass beads resulting in the appearance of “vacuoles” between the phases. Partial recovery of the wetting process was observed after the load removal.

The dynamic properties of the filled epoxy

resin changed in a slightly different manner than those of the unfilled material. When small stresses (60 and 117 kg cm^{-2}) were applied to the filled epoxy resin samples, an immediate decrease of the storage and loss moduli to a constant value occurred. When larger stresses (137 and 157 kg cm^{-2}) were applied, there was a sharp drop in the moduli which gradually diminished to constant values. When the specimen was loaded with the highest stress (204 kg cm^{-2}), a sharp decrease in the moduli occurred; the storage modulus continued to decrease and the loss modulus decreased gradually to a constant value till failure took place. It is interesting to note, that contrary to the behaviour of the unfilled material, no rise in the loss modulus but a decrease of its value was observed till the failure of the specimen occurred.

When specimens were relieved from the action of the small stresses (60 , 117 and 137 kg cm^{-2}) there was an immediate recovery of the moduli to their initial values, as observed also in the case of the unfilled material. When a stress of 157 kg cm^{-2} was removed there was a certain

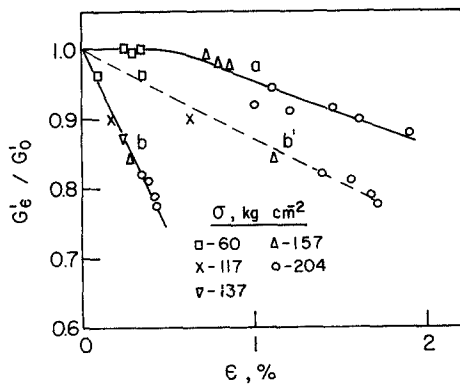

Figure 5 Relative real modulus versus axial deformation for (a) unfilled and (b) filled EPON Resin at different stresses.

immediate recovery of the storage modulus and then a gradual one took place. The loss modulus "jumped" over its initial value, and then slowly decreased until it reached this value again. It must be noted that in all cases of filled specimens there was an immediate rise in the storage modulus when the load was removed. On the other hand, when an unfilled specimen relaxed from the stress of 204 kg cm⁻² the recovery of the storage modulus was gradual. The "jump" in the experiments with the filled material may be a result of a quick matrix-filler reunion as observed through the optical microscope when the load was released.

In order to consider the parameters influencing the dynamic properties of the material on stretching, the dependency of the real modulus on deformation was shown in Fig. 5. It can be seen that experimental points, which represent different stresses, lie on the same curve and this indicates that the real modulus is a function of deformation only, both for the unfilled and filled materials.

In an unfilled material there is no change in the real modulus up to strains of about 0.5%, which is in agreement with the results of Lifshitz and Rotem [14]. The decrease in the real modulus at strains larger than 0.5% is moderate and reaches 15% of the initial value of the real modulus at a strain of 1.9%.

The reason for the decrease in the real modulus of the unfilled material is not clear. Lifshitz and Rotem suggested that the decrease may be due to formation of microvoids in the material, yet our microscopic observations (resolution = 3 μm) did not confirm this explanation.

In a filled material the decrease of the real modulus is rapid and it reaches at a strain of 0.43%, 27% of the initial value of the real modulus. No

region in which strains do not influence the real modulus can be seen in curve b of Fig. 5, but the existence of such a region at very small deformations cannot be absolutely denied.

The curves shown in Fig. 5 may lead to an idea that the general behaviour of the unfilled and filled materials can be perhaps attributed to processes occurring in the matrix during straining. Such processes should be intensified in the filled materials because only the matrix, which forms a part of the material, is deformed.

Bueche [18] suggested a simple method to calculate the strain in the matrix of a filled material in which the filler is infinitely rigid as compared to the matrix. According to Bueche, the strain in the matrix is calculated by dividing the strain of the filled material by the factor $1 - \phi^{1/3}$ in which ϕ is the volume fraction of the filler.

The curve b' in Fig. 5 represents the relative storage modulus of the filled specimens versus the effective deformation in the matrix in those specimens built by use of Bueche's approach. It is evident from this curve that the change in the storage modulus is not only due to processes considered before. One of the possible explanations of the difference between the behaviour of the materials as shown by curves b' and a, are wetting-dewetting phenomena occurring in the matrix-filler interphase, but this assumption requires further investigation.

The relationship between the relative loss moduli and deformation for unfilled and filled resins subjected to various tension stresses, is shown in Fig. 6. It is evident that the loss modulus does not depend on the deformation only, but also on the stress, a result which agrees with data published by Crissman and Zapas [13] for $\tan \delta$ in other materials. The results obtained in this study at small stresses, namely, the decrease in the loss modulus, are comparable to the results of Crissman and Zapas at deformations up to 10%. Since Lifshitz and Rotem did not notice any decrease in $\tan \delta$, their observations may be due to the different nature of their experiment. In an unfilled material the rate of decrease of the loss modulus with deformation drops with the application of a higher stress, while at a very high stress, at much higher deformations, when the specimen is already approaching failure, the loss modulus increases. On the other hand, in a filled material there is a reduction in the rate of decrease of the loss modulus even when the specimen

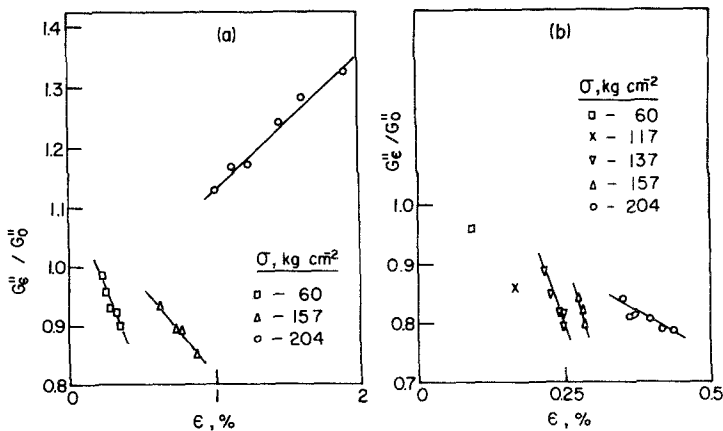

Figure 6 Relative loss modulus versus axial deformation for unfilled (a) and filled (b) EPON Resin at different stresses.

approaches failure at a high stress. This indicates that the fracture process is affected not only by the nature of the matrix, but is also influenced by the filler–matrix interaction and separation.

It has already been shown, that the change in the real modulus during extension is fully determined by the magnitude of the axial deformation (Fig. 5). Yet, no such clear dependency was found for the loss modulus (Fig. 6), and this was also observed by Falk *et al.* [13] in their work. It seems, therefore, that the stress must also be considered, when a correlation between the loss modulus and the axial deformation is searched for.

The mechanical energy, E , needed to stretch a unit volume of a material to a deformation ϵ is given by: $E = \int_0^\epsilon \sigma(\epsilon) d\epsilon$, where $\sigma(\epsilon)$ is the tensile stress. This energy may affect the properties of the material, especially at high deformations (example by orientation). When two modes of stressing are simultaneously applied, as in the experimental

work described herewith, the energy E which is absorbed by the material during extension, will influence the energy dissipated in the material due to an oscillatory torsional stressing. The energy, W , lost in one torsional cycle per unit volume, when a tensile stress is also acting, is given by: $W = \pi G''(\sigma, \epsilon) \gamma_0^2$, where G'' is the loss modulus at a constant frequency and γ_0 is the maximum amplitude of torsional strain. The ratio W/E plotted as a function of deformation for the two types of materials examined in this work is shown in Fig. 7, lines 1 and 2, and compared with the results of Lifshitz and Rotem, lines 3 and 4. For the sake of computation simplicity, the value of γ_0 was assumed to be 1. This assumption causes no error because the materials are tested in the linear region of their behaviour and G'' does not depend on the amplitude, which is very small. In order to compute E , data for curves of σ versus ϵ were derived from the creep data obtained in

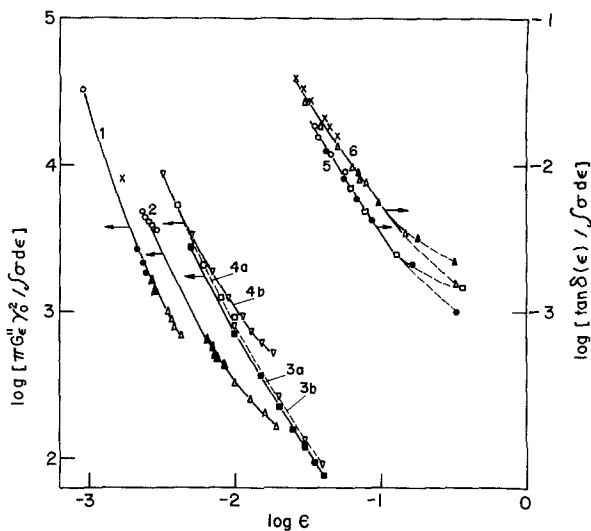

Figure 7 $\log \pi G''_\epsilon \gamma_0^2 / \int_0^\epsilon \sigma d\epsilon$ and $\log \tan \delta(\epsilon) / \int_0^\epsilon \sigma d\epsilon$ versus \log axial deformation for: 1 and 2, filled and unfilled EPON 826 Resins, respectively, at different stresses (our data); 3 and 4, unfilled and filled EPICOTE 815 Resins, respectively, at different strain rates (filled symbols $44.7 \times 10^{-4} \text{ min}^{-1}$, unfilled symbols $4.47 \times 10^{-4} \text{ min}^{-1}$ [14]); 5 and 6, polyethylene and ethylene–hexene copolymer, respectively, at different stresses [12].
 5: \circ – 136, \bullet – 180, \square – 212.5 kg cm^{-2}
 6: \times – 135, \triangle – 175, \blacktriangle – 201.5 kg cm^{-2}

this work at various fixed times and the appropriate integral was calculated for each deformation. The energy E in the experiments of Lifshitz and Rotem was calculated from the σ versus ϵ data, listed in their paper.

As seen in Fig. 7, each material possesses a typical curve of the ratio of energies versus deformation. The common characteristic of all the materials tested is that their ability to dissipate energy while being under tension decreases with deformation.

On the right-hand side of Fig. 7 the data obtained by Crissman and Zapas for polyethylene (curve 5) and ethylene-hexene co-polymer (curve 6) are shown. As no data regarding the real or loss moduli in their work were published, the ratio $\pi G'' \gamma_0^2 / \int_0^\epsilon \sigma \, d\epsilon$ could not be calculated, and instead, the curves 5 and 6 represent the relation $\tan \delta / \int_0^\epsilon \sigma \, d\epsilon$ versus ϵ after the data were interpreted in the same manner as the results of our work. It can be seen from these curves that the ratio $\tan \delta(\epsilon) / \int_0^\epsilon \sigma \, d\epsilon$ does not depend on the tensile stress up to a deformation of 16%.

At deformations larger than 16% there is a difference in this ratio, depending on the acting stress. This dependence may be due either to neck formation before fracture, or the change of the modulus with deformation.

4. Conclusions

The real moduli of unfilled and filled epoxy resins diminish during extensional creep, and in most cases, a decrease of the loss moduli of the investigated materials can also be noted. Most of the initial dynamic moduli values are recovered after the specimens relax from the applied load. The larger change in the dynamic moduli of the filled material can be explained by wetting-dewetting processes occurring in the filler-matrix interphase.

A correlation between the energy loss, the energy input and the axial strain was found and this correlation applies also for other polymers.

References

1. J. D. FERRY, "Viscoelastic Properties of Polymers", (Wiley, New York, 1970) p. 151.
2. L. E. NIELSEN, "Mechanical Properties of Polymers and Composites", Vol. 2 (Marcel Dekker, New York, 1970) p. 11.
3. I. M. WARD, "Mechanical Properties of Solid Polymers" (Wiley, London, 1971) p. 95.
4. R. I. TANNER and J. M. SIMMONS, *Chem. Eng. Sci.* **22** (1967) 1803.
5. T. KATAKE and R. OSAKI, *J. Polymer Sci.* **15** (1966) 453.
6. H. C. BOOIJ, *Rheol. Acta* **5** (1966) 215; **7** (1968) 202.
7. I. F. MACDONALD, *Trans. Soc. Rheol.* **17** (1973) 537.
8. A. I. LEONEV, M. G. TSIPRIN and L. A. FEYTELSON, *Polymer Mechanics* **3** (1969) 519.
9. A. I. ISAYEV, A. K. KULAPOV and G. V. VINOGRADOV, "Vibratsionnaya Viscosimetriya", edited by C. C. Kutateladze (Novosibirsk, 1976).
10. A. N. PROKUNIN, A. I. ISAYEV and E. K. LIPKINE, *Polymer Mechanics* **4** (1977) 699.
11. I. P. BRIEDIS and V. V. LEITLAND, *ibid* **5** (1977) 901.
12. J. M. CRISSMAN and L. J. ZAPAS, *J. Appl. Phys.* **48** (1977) 4049.
13. O. FALK, J. KUBAT and M. RIGDAHL, *J. Mater. Sci.* **13** (1978) 2328.
14. J. M. LIFSHITZ and A. ROTEM, *J. Comp. Mater.* **3** (1969) 412.
15. D. KATZ and A. BUCHMAN, *Polymer Eng. Sci.* **17** (1977) 2.
16. M. A. BIOT, *J. Appl. Phys.* **10** (1939) 860.
17. C. J. NEDERVEEN and C. W. VAN DER WAL, *Rheol. Acta* **6** (1967) 316.
18. F. BUECHE, *J. Appl. Polymer Sci.* **4** (10) (1960) 107.
19. L. E. NIELSEN, *ASTM Bulletin*, April (1950) p. 48.

Received 21 August and accepted 24 September 1979